

FREE DIMENSION TOLERANCES (REF. DIN 16901)

ABOVE	0	1	3	6	10	15	22	30	40	53	70	90	120	160	200	250	315	400	500	630	800
UP TO	1	3	6	10	15	22	30	40	53	70	90	120	160	200	250	315	400	500	630	800	1000
TOLERANCE	± 0.10	± 0.11	± 0.12	± 0.14	± 0.17	± 0.20	± 0.24	± 0.28	± 0.33	± 0.40	± 0.50	± 0.60	± 0.75	± 0.95	± 1.15	± 1.45	± 1.80	± 2.20	± 2.80	± 3.50	± 4.40

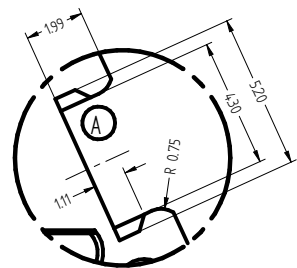

DETAIL F

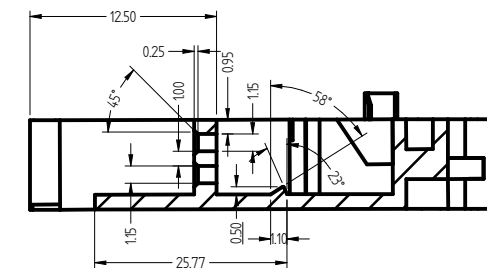
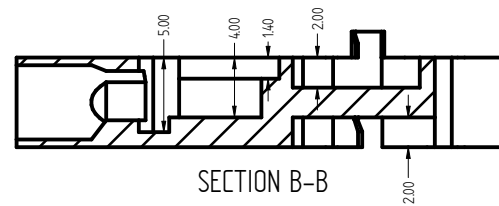
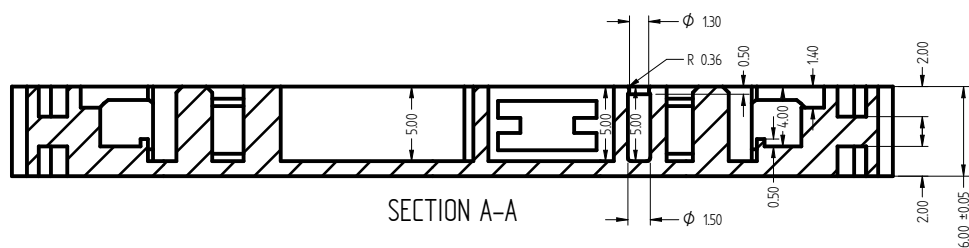
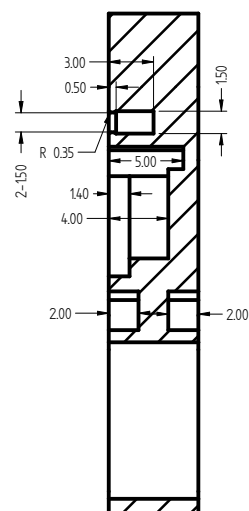

SECTION D-D

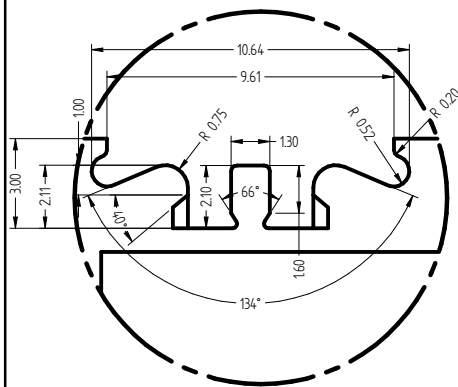
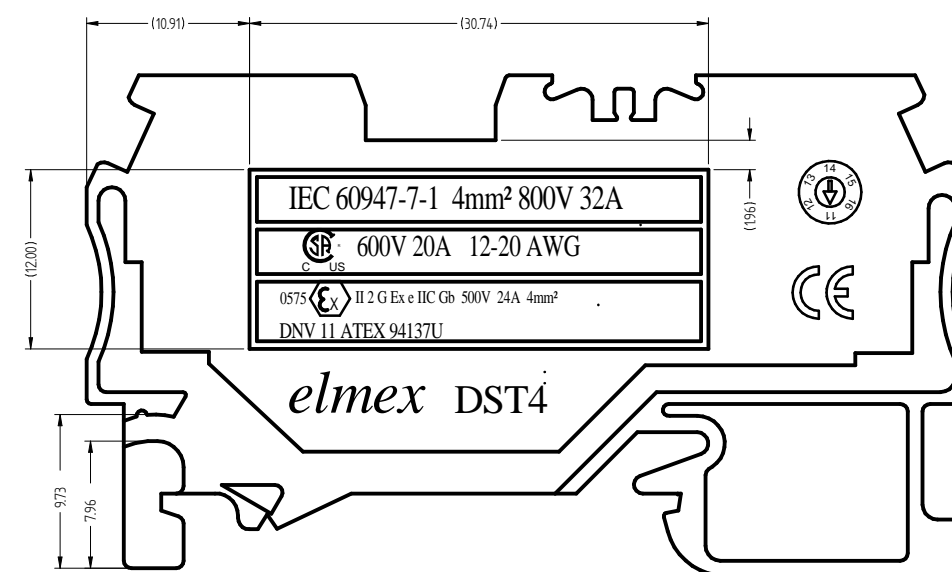
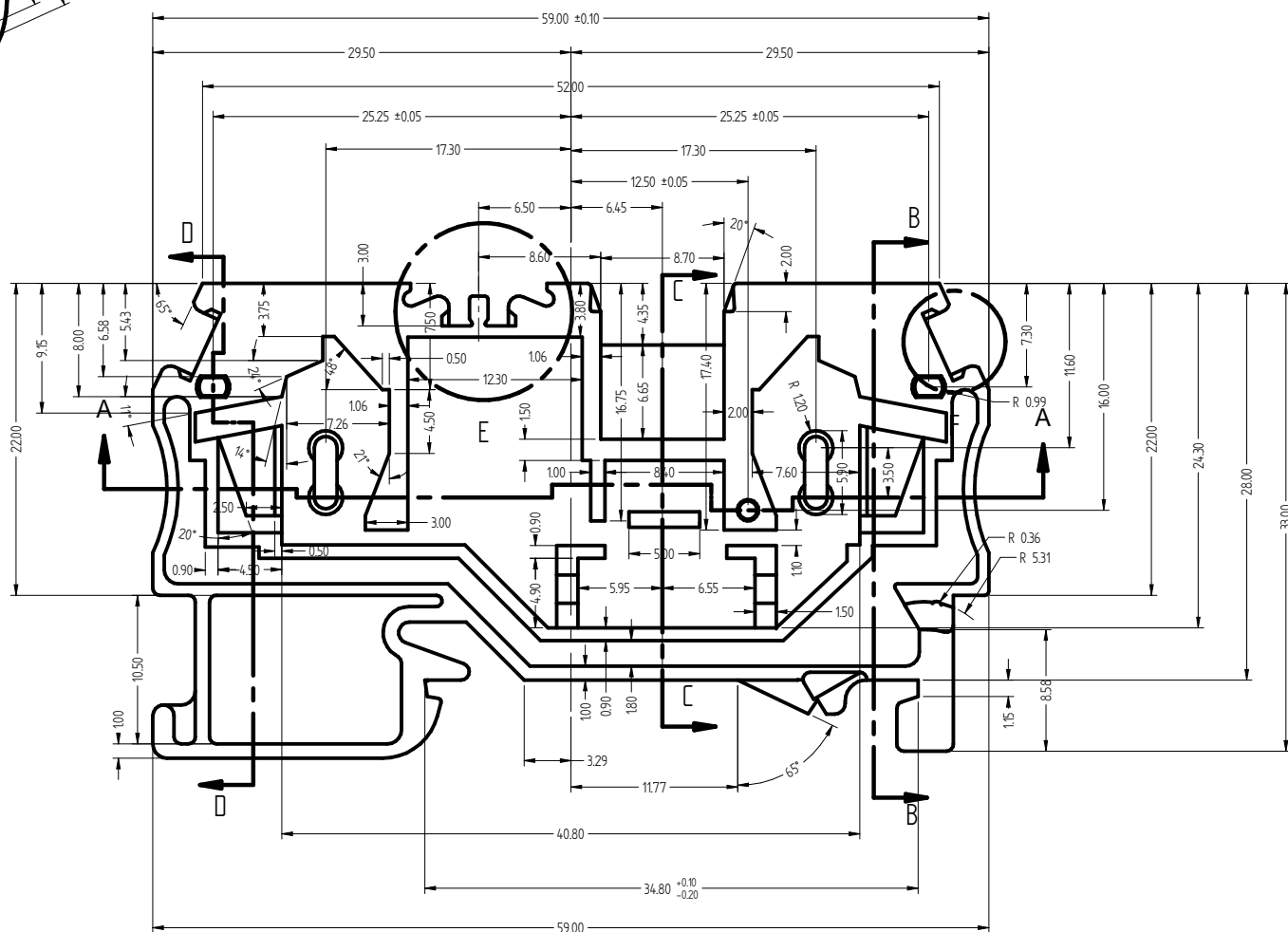

DETAIL E

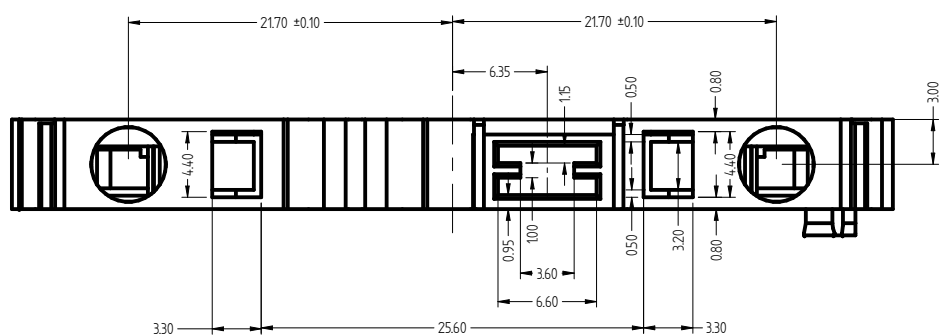

B	ADDED ATEX AND CSA MARKING	Bhaskar	30-04-2011
A	ADDED MARKING WINDOW STOPPER	B.B.P	05-08-2010
CHANGE LETTER	REVISION BRIEF RECORD	CHANGED BY.	DATE

Reqd. No.	Dash No.	Size	Material
Drn. By.	I.P.Khatri	16-07-07	Chd. By.
Scale 2:1	HOUSING		
3 6DST4H		IM	2
elmex			

APPROVED DRG.